

# DCR-89+

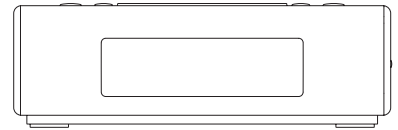

**GB**

Revision 2

## Contents

<i>Controls</i> .....	2-3	<i>Brightness control</i> .....	20
<i>Using the clock radio for the first time</i> .....	4	<i>Software version</i> .....	20
<i>Operating your clock radio</i> .....	4	<i>Auxiliary input socket</i> .....	21
<i>Selecting a station - DAB</i> .....	5	<i>Headphone socket</i> .....	21
<i>Secondary services - DAB</i> .....	5	<i>Line out socket</i> .....	21
<i>Display modes - DAB</i> .....	6	<i>System reset</i> .....	22
<i>Finding new stations - DAB</i> .....	7	<i>Software upgrade</i> .....	23
<i>Manual tuning - DAB</i> .....	7	<i>USB socket for iPhone/Smartphone charging</i> .....	24
<i>Prune stations - DAB</i> .....	8	<i>Cautions</i> .....	24
<i>Dynamic range control (DRC) settings - DAB</i> .....	9	<i>Specifications</i> .....	25
<i>Station order setup - DAB</i> .....	9		
<i>Operating your radio - Manual tune - FM</i> .....	10		
<i>Display modes - FM</i> .....	11		
<i>Scan setting</i> .....	11		
<i>FM stereo/mono</i> .....	12		
<i>Presetting stations - DAB &amp; FM</i> .....	12		
<i>Recalling a preset station - DAB &amp; FM</i> .....	13		
<i>Setting time format</i> .....	13		
<i>Automatically updating the clock</i> .....	14		
<i>Setting the clock manually</i> .....	15		
<i>Setting the alarm times</i> .....	16-17		
<i>Cancelling alarms</i> .....	18		
<i>To view the alarm settings</i> .....	18		
<i>Snooze</i> .....	18		
<i>Nap timer</i> .....	18		
<i>Sleep timer</i> .....	19		
<i>Language</i> .....	19		
<i>Display backlight</i> .....	19		

## Controls

GB

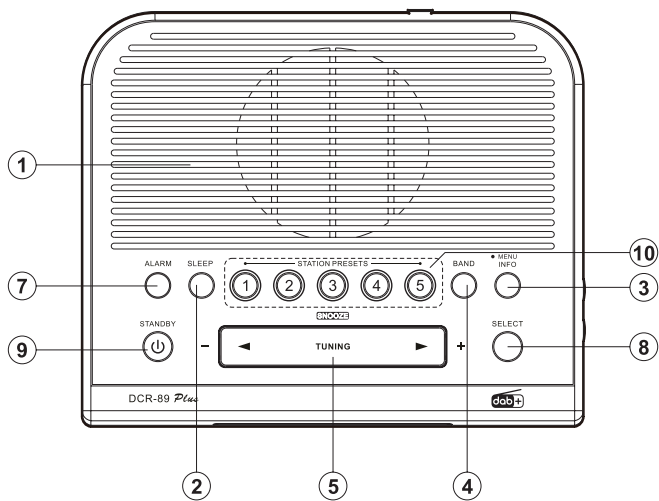

1. Loudspeaker
2. Sleep button
3. Menu/Info button
4. Band button
5. Tuning Up/Down/Snooze button

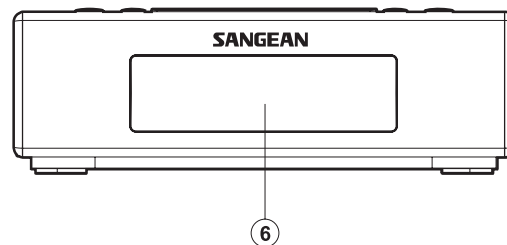

6. LCD display
7. Alarm button
8. Select button
9. On/Standby button
10. Station preset buttons

## Controls

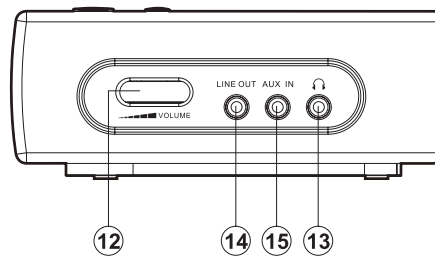
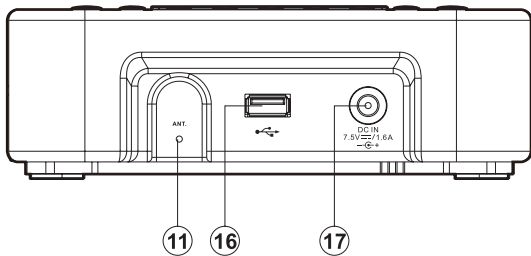

- 11. Wire antenna
- 12. Volume control
- 13. Headphone socket
- 14. Line out socket
- 15. Auxiliary in socket
- 16. USB socket
- 17. DC jack socket

## Using the clock radio for the first time

1. Place your clock radio on a flat surface.
2. Fully extend the wire aerial located on the rear of your clock radio. Place the wire antenna so that it is as straight as possible extending either above or below the radio.
3. Insert the supplied adaptor plug into the DC socket located on the rear of your clock radio. Plug the adaptor into a standard mains socket outlet. The display will show "Welcome to Digital Radio" for a few second and then display will show "0:00".
4. The clock will be auto adjusted by the DAB station you tune to or you may refer to "Setting the clock manually" described later for clock setting.

### **IMPORTANT:**

The mains adaptor is used as the means of connecting the clock radio to the mains supply. The mains socket used for the clock radio must remain accessible during normal use. In order to disconnect the clock radio from the mains completely, the adaptor should be removed from the mains socket outlet completely.

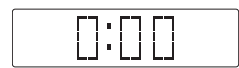
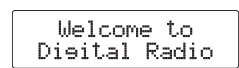
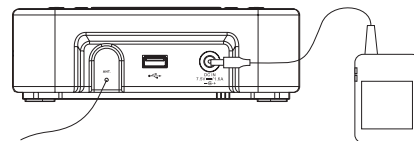

## Operating your clock radio

1. Press the On/Standby button to switch on your clock radio. Press the Band button to select DAB mode.
  2. If this is the first time the radio is used, a quick scan of the Band III DAB channels will be carried out. If the radio has been used before, the last used station will be selected.
  3. During the scanning process, as new stations are detected, the station counter on the right hand side of the display will increase and stations will be added to the list. The lower line of the display shows a bar-graph indicating progress of autotune.
- The display will revert to a conventional time display 10 seconds after the last button press except when displaying scrolling text.

### **Note:**

If you can see the name of the radio station on the display, but cannot hear any sound, you may need to adjust the volume control which is located on the right hand side of your clock radio.



## Selecting a station - DAB

1. Press the On/Standby button to switch on your clock radio.
2. Press the Band button to select DAB mode. The display will show the name of the radio station currently selected.
3. Press the Tuning Up/Down buttons to scroll through the list of available stations.
4. Press and release the Select button to select the station. The display will show "Connecting" for a few seconds. The top line of the display shows the name of the station currently selected.
5. Adjust the Volume control to the required setting.

### Note:

If after selecting a station the display shows "Service not available". it may be necessary to relocate your radio to a position giving better reception.

## Secondary services - DAB

1. Certain radio stations have one or more secondary services associated with them. If a station has a secondary service associated with it the display will show ">>" next to the station name on the station list. The secondary service will then appear immediately after the primary service as you press the Tuning Up button.
2. To tune to the secondary service, press and release the Select button. Most secondary services do not broadcast continually and if the selected service is not available, the radio will re-tune to the associated primary service.

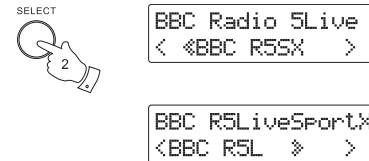
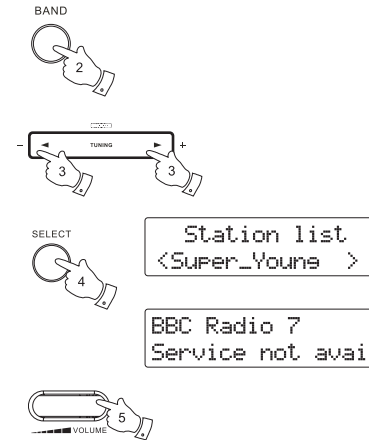

## Display modes - DAB

Your radio has eight display modes:-

1. Press the Info button to cycle through the various modes.
  - a. Time Displays the current time.
  - b. Date Displays the current date.
  - c. Scrolling text Displays scrolling text messages such as artist/track name, etc.
  - d. Program Type Displays the type of station being listened to, e.g. Pop, Classic, News etc.
  - e. Multiplex Name Displays the name of DAB multiplex to which the current station belongs.
  - f. Frequency Displays the frequency of the DAB multiplex for the station being listened to.
  - g. Bit rate and audio type Displays the digital bit rate & audio type for the station being listened to.
  - h. Signal strength Displays a graph showing the signal strength for the station being received.

• MENU  
INFO



a BBC RADIO 7  
19:17

b BBC RADIO 7  
08-06-2017

c BBC RADIO 7  
Jane Jones Pres

d BBC RADIO 7  
Varied Speech

e BBC RADIO 7  
BBC Natinal

f BBC RADIO 7  
12B 225.64MHz

g BBC RADIO 7  
96kbps / AAC

h BBC RADIO 7  
■■■■□■■■■

## Finding new stations - DAB

From time to time, new DAB radio stations may become available. Or you may have moved to a different part of the country. In this case you may need to cause your radio to scan for new stations.

1. Press the Band button to select DAB radio mode.
2. Once in DAB mode, press and hold the Menu button.
3. Press the Tuning up/down button until 'Scan' is highlighted on the display.
4. Press the Select button to initiate the scan. The display will show 'Scanning' and your radio will perform a scan of the DAB Band III frequencies. As new stations are found the station counter will increase and stations will be added to the list. The bar graph indicates the progress of the scan.

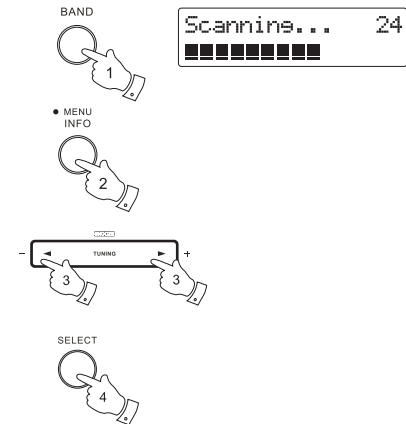

## Manual tuning – DAB

Manual tuning allows you to tune your radio to a particular DAB frequency in Band III. Any new stations found will be added to the station list. This function can also be used to assist the positioning of the aerial or radio to optimise reception for a specific channel or frequency. Note that DAB stations are located in the range of channels 9A to 13F.

1. Press and hold the Menu/Info button to enter the menu setting.
2. Press the Tuning up/down button until 'Manual Tune' shown on the display. Press the Select button to enter the setting.
3. Press the Tuning Up or Down buttons to select the required DAB channel. Press and release the Select button to tune to the chosen frequency. The clear unfilled rectangle indicates the minimum signal level required for satisfactory reception. The signal strength bar will go up and down showing the changing signal strength as you adjust the wire antenna on your radio. When a DAB signal is found, the display will show the name of the DAB multiplex. Any new radio stations found will be added to the list stored in the radio.
4. Press and release the Select button to return to the normal DAB tuning mode.

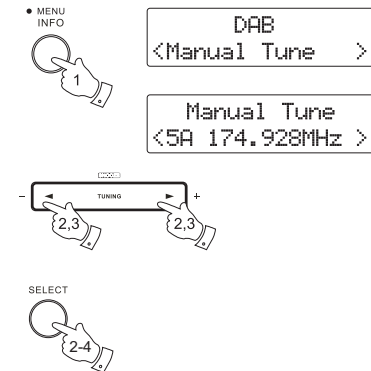



## Prune stations - DAB

Over time, some DAB services may stop broadcasting, or may change location and then not be able to receive a station. In order to remove such stations from the DAB station list, the Prune stations function will delete the DAB stations from your station list that can no longer be received. Stations which cannot be found or which have not been received for a very long time are shown in the station list with a question mark.

1. Press the On/Standby button to switch on your radio.
2. Press the Band button until the DAB mode is selected.
3. Press and hold the Menu/Info button to enter the DAB menu setting.
4. Press the Tuning up/down button until 'Prune' appears on the display. Press the Select button to enter the setting.
5. Press the Tuning up/down button to highlight 'Yes'. Press the Select button to cause the stations list to be pruned, eliminating unavailable stations.
6. If you do not wish to prune stations highlight 'No' in step 5 and then press and release the Select button. The display will revert back to the previous display.

**Note:** If you have moved to a different part of the country you should also carry out a search for new stations (please see the section 'Finding new stations' in previous section).

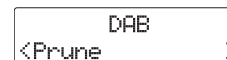

```
DAB
<Prune >
```

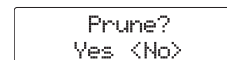

```
Prune?
Yes <No>
```

## Dynamic Range Control (DRC) settings - DAB

The DRC facility can make quieter sounds easier to hear when your radio is used in a noisy environment.

There are three levels of DRC compression:

DRC Off No compression applied

DRC Low Medium compression applied

DRC High Maximum compression applied

1. Press and hold the Menu/Info button to enter the menu setting.
2. Press the Tuning up/down button until 'DRC Value' shown on the display. Press the Select button to enter the setting. The display will show the current DRC value.

**Note:** The current setting is indicated by an asterisk.

3. Press the Tuning Up or Down buttons to select required DRC setting.
4. Press and release the Select button to confirm the setting. The display will return to the normal radio display.

### **Note:**

Not all DAB broadcasts are able to use the DRC function. If the broadcast does not support DRC, then the DRC setting in the radio will have no effect.

## Station order setup - DAB

Your radio has 3 station order settings from which you can choose. The station order settings are alphanumeric, active and ensemble.

1. When in DAB mode press and hold the Menu/Info button to enter the DAB menu.
2. Press the Tuning up/down button to select the "Station order".
3. Press the Select button to enter the station order adjustment mode.
4. Press the Tuning up/down button to choose "Alphanumeric", "Active" and "Ensemble".
  - "Alphanumeric" - sorts the station list alpha-numerically 0...9 A...Z.
  - "Active" - shows only those stations for which a signal can be found.
  - "Ensemble" - organizes the station list by DAB multiplex.

The current setting is indicated by an asterisk.

5. Press the Select button to confirm the required station order.

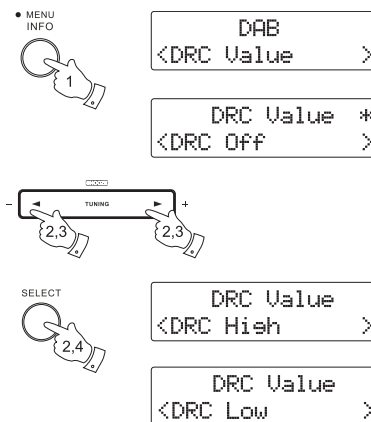

## Operating your radio - Manual tune - FM

1. Fully extend the wire aerial located on the rear of your clock radio. Place the wire antenna so that it is as straight as possible extending either above or below the radio.
2. Press the On/Standby button to switch on your clock radio.
3. Press the Band button to select the FM band.
4. Press the Tuning Up or Down buttons to tune to a station. The frequency will change in steps of 50kHz. To scan up in frequency, press and hold the Tuning Up button. Your radio will scan in an upwards direction (low frequency to high frequency) and stop automatically when it finds a station of sufficient strength. To scan down in frequency, press and hold the Tuning Down button. Your radio will scan in a downwards direction and stop automatically when it finds a station of sufficient strength. After a few seconds the display will update. The display will show the frequency of the signal found. If the radio is tuned to a station of sufficient signal strength with RDS information present, then the display may change to show the station name.
5. When the end of the waveband is reached the radio will recommence tuning from the opposite end of the waveband.
6. Set the Volume to the desired setting.
7. To switch off your clock radio press the Standby button.

### Note:

The display will revert to a conventional time display 10 seconds after the last button press except when displaying scrolling text.

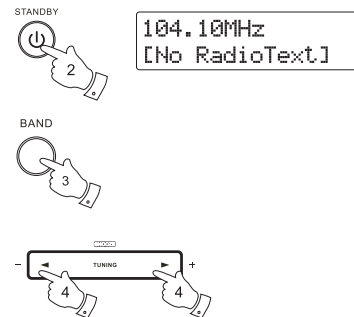

## Display modes - FM

Your radio has a range of display options when in FM mode. Note that the display will revert to a conventional time display 10 seconds after the last button press except when displaying scrolling text.

The Radio Data System (RDS) is a system in which inaudible digital information is transmitted in addition to the normal FM radio programme.

RDS offers several useful features.

1. Press the Info button to cycle through the various options.
  - a. Time Display the current time.
  - b. Date Display the current date.
  - c. Scrolling text Displays scrolling text messages such as artist/track name, phone in number, etc.
  - d. Programme type Displays type of station being listened to e.g. Pop, Classic, News, etc.
  - e. Station name Displays the name of the station being listened to.
  - f. Audio type Display the audio type of the station being listened to.

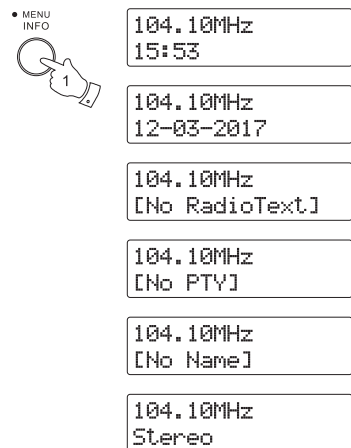

## Scan setting

When using the FM mode your radio can be set to either scan local stations or to scan all stations including distant radio stations.

1. Press the Band button as needed to select FM radio mode.
2. Press and hold the Menu/Info button to enter the FM menu. Press the Tuning up/down button until 'FM Scan Zone' is highlighted and then press the Select button to enter the scan adjustment mode.
3. To set your radio so that only the stations with the strongest signals are found during scanning press the Tuning Up or Down buttons until 'Local' is highlighted. Press the Select button to confirm the setting. (Normally this will restrict scanning to local transmissions.) Alternatively, to set your radio so that all available stations are found during scanning (local and distant transmissions) press the Tuning Up or Down buttons until 'Distant' is highlighted. Press the Select button to confirm the setting.

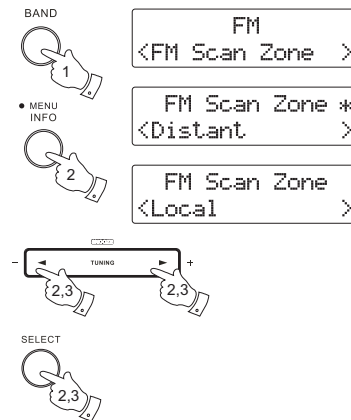

## FM stereo/mono

If the FM radio station being listened to has a weak signal some hiss may be audible. It is possible to reduce this hiss by forcing the radio to play the station in mono rather than stereo.

1. Press the Band button as needed to select the FM radio mode and tune to the required FM station as previously described.
2. Press and hold the Menu/Info button to enter the menu setting.
3. Press and release the Tuning up/down button until 'FM Audio' shown on the display. Then press the Select button to enter the setting. If the setting is Auto press the Tuning up/down button to switch to Mono mode to reduce the hiss.
4. To return to Auto (stereo) mode press and release the Tuning up/down button again, so that the digital receiver will switch back to Auto mode.

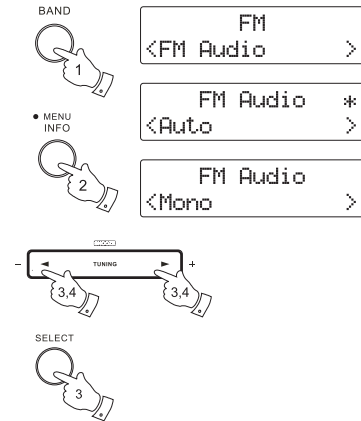

## Presetting stations

You may store your preferred DAB and FM radio stations to the preset station memories. There are 10 memory presets in your radio, 5 for DAB and 5 for FM. Presets are remembered by your radio in the event of a power failure.

The procedure for setting presets and using them to tune stations is the same for FM and DAB modes, and is described below.

1. Press the On/Standby button to switch on the clock radio.
2. Tune to the required station as previously described.
3. Press and hold down the required Preset button until the display shows, for example, "Preset 1 stored". The currently tuned station will be stored under the chosen preset button. Repeat this procedure for the remaining presets as needed.
4. Stations which have been stored in preset memories may be over written by following the above procedure.

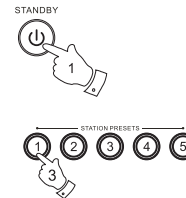

## Recalling a preset station

1. Press the On/Standby button to switch on the clock radio.
2. Press the Band button to select the desired waveband.
3. Momentarily press the required Preset button. Your clock radio will tune to the station stored in the preset memory.

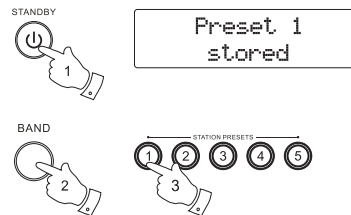

## Clock and Alarms

### Setting the time format

The clock display used in stand-by mode and on the playing mode screens can be set to 12 or 24 hour format.

The selected format is then also used when setting the alarms.

1. Press the On/Standby button to switch on your radio. When the radio is in DAB or FM mode, press and hold the Menu/Info button to enter the menu setting.
2. Press the Tuning up/down button until 'System setting' shown on the display, then press the Select button to enter the setting menu.
3. Press the Tuning up/down until 'Time' is shown on the display, press the Select button to enter the setting menu.
4. Press the Tuning up/down button until 'Set 12/24 Hour' is shown on the display, press the Select button to enter the setting menu.
5. Press the Tuning up/down to select either 12 or 24 hour format. Press the Select button to confirm your choice of clock format.

### Note:

If the 12 hour clock format is chosen, the radio will then use the 12 hour clock for the setting of alarms with a PM indicator.

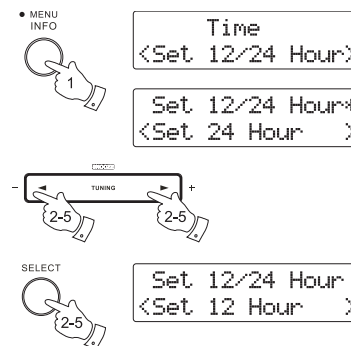

## Automatically updating the clock

You can specify that the unit sets its clock from DAB or FM radio broadcasts.

After a power failure the radio will then set its clock the next time that you turn on the radio in DAB or FM mode. Alternatively you can specify that the time is not automatically updated. In this case the clock must always be set manually after a power interruption.

1. With your radio switched on, when the radio is in DAB or FM mode, press and hold the Menu/Info button to access the setting menu.
2. Press the Tuning up/down button until 'System setting' is highlighted on the display. Press the select button to enter the setting.
3. Press the Tuning up/down button until 'Time' is highlighted on the display. Press the Select button to enter the setting.
4. Press the Tuning up/down button until 'Auto update' is highlighted on the display. Press the Select button to enter the setting.
5. Press the Tuning up/down button to choose an update option from 'Update from DAB', 'Update from FM', 'Update from Any' or 'No update' as required. Press the Select button to confirm your choice. The radio will then exit to the previous menu setting.

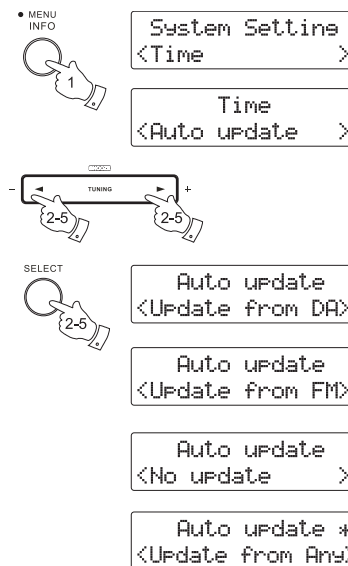

## Setting the clock manually

Normally your clock radio will set its clock automatically via the DAB signal.

If no DAB signal is available and you need to set the time manually, please follow the procedure shown below.

### Note:

The DAB signal will always override any manual time setting.

1. To set the clock time, press the On/Standby button to switch on the clock radio. When the radio is in DAB or FM mode, press and hold the Menu/Info button to enter the menu setting.
2. Press the Tuning up/down button until 'System setting' is shown on the display. Press the Select button to enter the setting.
3. Press the Tuning up/down button until 'Time' is shown on the display. Press the Select button to enter the setting.
4. Press the Tuning up/down button until 'Set Time/Date' is shown on the display. Press the Select button to enter the setting.
5. The hour digit will flash on the display. Press the Tuning up/down button to choose the desired clock hour. Press the Select button to confirm the setting.
6. The minute digit will flash on the display. Press the Tuning up/down button to choose the desired clock minute. Press the Select button to confirm the setting.

**Note:** If the radio has been set to use a 12 hour format, there will be an option here for setting AM or PM for the clock time. Press the Tuning up/down button to select AM or PM. Press the Select button to confirm the setting.

7. The date digit will then flash on the display. Press the Tuning up/down to choose the desired date. Press the Select button to confirm the setting.
8. The month digit will flash on the display. Press the Tuning up/down to choose the desired month. Press the Select button to confirm the setting.
9. The year digit will flash on the display. Press the Tuning up/down button to confirm the setting. Press the Select button to confirm the setting. Now the clock is completed and 'Time Saved' is shown on the display.

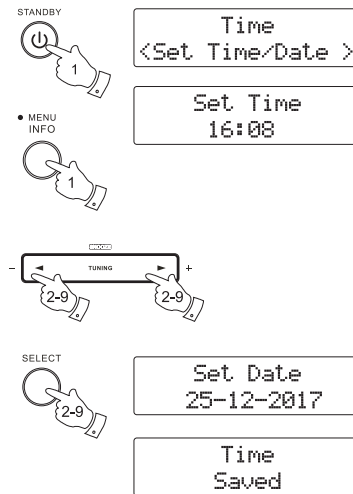



## Setting the alarm times

Your clock radio has two alarms which can be set to wake you to either radio or buzzer alarm. Each alarm can be set to sound once, daily, on weekdays or at weekends. Ensure that the time is set correctly before setting the alarms.

1. Press and release the Alarm button. (**Note:** If the time is not set before setting the alarms, "Set Time" will show on the display. Use the Tuning up/down button and Select button to set the time and date. When the setting is complete, proceed to step 2.)
2. The display will show "Alarm 1 setup" or press the Alarm button again to enter 'Alarm 2 setup.'
3. Press the Select button to enter the alarm setting and the display will show 'Alarm 1 Wizard' or 'Alarm 2 Wizard.'
4. Press the Tuning Up or Down buttons to choose between 'Alarm On' or 'Alarm Off' and press the select button to confirm the setting. Choose 'Alarm On' to continue the alarm setting. If 'Alarm Off' is selected, the current setting for that alarm will be cancelled.
5. Press the Tuning up/down to select the desired hour. Press the Select button to confirm the setting.
6. Press the Tuning up/down button to select the desired minute. Press the Select button to confirm the setting.
7. Press the Tuning up/down button to select the duration for the current setting alarm. The options are 15, 30, 45, 60, 90, 120. Press the Select button to confirm the setting.
8. Press the Tuning up/down button to choose the desired alarm source (DAB, FM, BUZZER). Press the Select button to confirm the setting. Press the Tuning up/down button to select the desired alarm volume and press the Select button to confirm the setting.

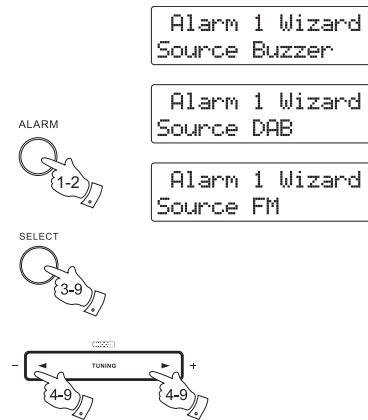

### Note:

When your alarm is set to wake up by DAB, your clock radio will automatically set to the last listened station. When FM is selected, the alarm can be set to any of the stations which have been stored as presets or to the station last listened to.

9. Press the Tuning up/down button to choose the alarm frequency options, as following:

'Once': the alarm will sound once

'Weekends': the alarm will sound only at weekends

'Weekdays': the alarm will sound on weekdays only

'Daily': the alarm will sound everyday

Press the Select button to confirm the setting. Your alarm setting is now completed. Active alarms are indicated in the display with letter "A". If you choose to set the alarm 'Once' you will also need to set the date using the Tuning up/down and the Select button.

**Note:**

The radio alarm will not be audible while you have any connection to the Aux In socket. The buzzer alarm may still be used.

**Note:**

If you make a mistake at any point while setting the alarms, press the Menu button to go back to the previous screen.



Alarm 2 Wizard  
Daily

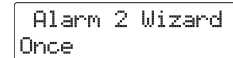

Alarm 2 Wizard  
Once

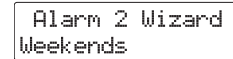

Alarm 2 Wizard  
Weekends

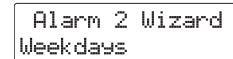

Alarm 2 Wizard  
Weekdays

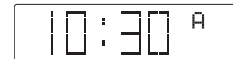

10:30 A

## Cancelling alarms

While an alarm is sounding it can be cancelled by pressing the On/Standby button.

## To view the alarm setting

1. Press the On/Standby button to switch on the clock radio.
2. Press the Alarm button and then the Select button to enter the setting.
3. Press the Tuning Up or Down buttons to view alarms 1 or 2.
4. Press the Select button to cycle through each of the settings for the chosen alarm.

You may use the Tuning Up and Down buttons to modify any particular setting if desired, using the Select button to enter the modification.

## Snooze

1. When the radio or buzzer alarm sounds, pressing the Snooze button will silence the alarm for the selected number of minutes. The Snooze down can be adjusted between 5 and 20 minutes in 5 minute increments. Default setting is 5 minutes. The display will show the Snooze symbol "Z". This sequence can be repeated during the 60 minute beep alarm period.
2. To adjust the silence time for the snooze timer, press and hold the Info/menu button to enter the menu setting when the radio is in DAB or FM mode.
3. Press the Tuning up/down button until 'System setting' is shown on the display. Press the Select button to enter the setting.
4. Press the Tuning up/down button until 'Snooze duration' is shown on the display. Press the Select button to enter the setting.
5. Press the Tuning up/down button to choose the desired snooze time to 5, 10, 15 or 20 minutes. Press the Select button to confirm the setting.

## Nap timer

1. Press and hold the Sleep button to enter the nap timer setting menu.
2. Press the Tuning up/down button to select your desired Nap time (1-120 minutes). Or repeatedly press the Sleep button to select your desired Nap time. The options are between 5 and 120 minutes in 5 minutes increments. Press the Select button to confirm the setting. Symbol "N" will show on the display. To cancel the nap function, select "Off" and then press the Select button. Symbol "N" will disappear on the display.
3. To cancel a sounding Nap timer, press the Standby button. If the tuning up/down button is pressed when the alarm is sounding, the snooze function will be activated.

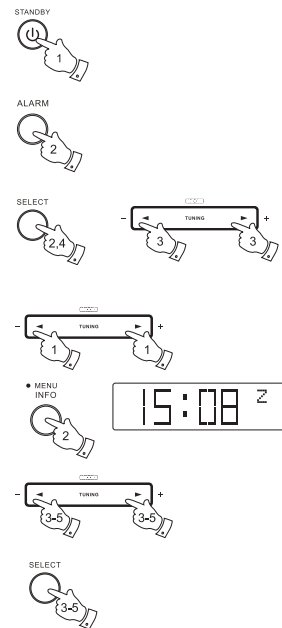

## Sleep timer

Your clock radio can be set to turn off after a preset time has elapsed.

The sleep setting can be adjusted between 15 and 120 minutes in 15 minutes increments.

Ensure your clock radio switched on.

1. To set the desired sleep time, press and release the Sleep button to enter the setting menu.
2. Repeatedly press the Tuning up/down button to select the desired sleep time. The options are between 15 and 120 minutes in 15 minutes increments. Press the Select button to confirm the setting. The display will show the sleep timer setting then exit the sleep options. The snooze indicator will be activated to show that the sleep timer is in use. Your clock will switch off after the preset time has elapsed.
3. To cancel the sleep timer function before the preset time has elapsed, press the Standby button. To cancel the sleep timer without switching off your radio, follow the procedures above and select the 'Sleep off' setting.

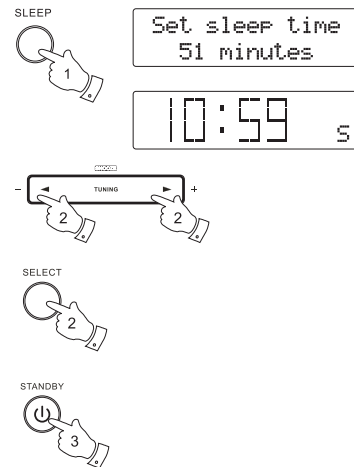

## Language

Your radio can be configured to a different language.

1. Press the On/Standby button to switch on the radio.
2. When the radio is in the DAB or FM mode, press and hold the Menu/Info button to enter the setting menu.
3. Press the Tuning up/down button until 'System Setting' is shown on the display. Press the Select button to enter the setting.
4. Press the Tuning up/down button to select 'Language'. Press the Select button to enter the setting.
5. Press the Tuning up/down button to select your required language. Press the Select button to confirm your selection. The display will change to the chosen language. The chosen language will be marked with an asterisk.

## Display backlight

1. In order to view the display when the display backlight is set to a low level, you can press any button (apart from the On/Standby button) to switch on the backlight without switching on the radio. The display brightness will increase for 10 seconds before returning to the previous level.

## Brightness control

The brightness of the display can be adjusted for when the radio is in standby and for when it is in use. If you use the unit in the bedroom, you may prefer a lower standby brightness level than a higher brightness setting.

1. Press the On/Standby button to switch on the radio.
2. When the radio is in the DAB or FM mode, press and hold the Menu/Info button to enter the setting menu.
3. Press the Tuning Up/down button until 'System Setting' is shown on the display. Press the Select button to enter the setting.
4. Press the Tuning up/down button until 'Backlight' is shown on the display. Press the Select button to enter the setting.
5. Press the Tuning up/down button to select the required the backlight level. Press the Select button to confirm the setting.

## Software version

The software display cannot be altered and is just for your reference.

Ensure your clock radio is switched on.

1. When the radio is in the DAB or FM mode, press and hold the Menu/Info button to enter the setting menu.
2. Press the Tuning Up/down button until 'System Setting' is shown on the display. Press the Select button to enter the setting.
3. Press the Tuning up/down button until 'SW Version' is shown on the display. Press the Select button to view the software version of your radio.

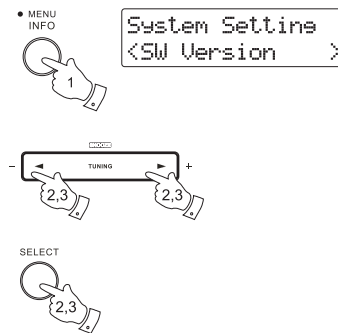

## Auxiliary input socket

1. A 3.5mm stereo Auxiliary Input socket is provided on the right hand side of your clock radio to permit an audio signal to be fed into the unit from an external audio device such as iPod, MP3 or CD player.
2. Press the On/Standby button to switch on the radio.
3. Press the Band button until 'AUX Mode' is shown on the display.
4. Press the 'play' on the connected audio device.
5. Adjust the volume control on your iPod, MP3 or CD player to a reasonably high level, and then adjust the Volume control on your clock radio for comfortable listening.

### Note:

Your radio alarm/DAB/FM will not be audible while you have any connection to the Aux in socket. The buzzer alarm may still be used.

**Note:** When the radio is in Auxiliary Input mode, if no controls are used and no audio signal from an external audio device for 15 minutes, the radio will be put into standby mode.

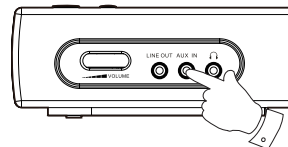

## Headphone socket

A 3.5mm Headphone Socket located on the right hand side of your clock radio is provided for use with either headphones or an earpiece. Inserting a plug automatically mutes the internal loudspeaker.

### IMPORTANT:

Excessive sound pressure from earphones and headphones can cause hearing loss. To prevent possible hearing damage, do not listen at high volume levels for long periods.

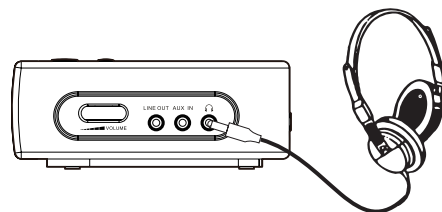

## Line out socket

A 3.5mm Line out socket located on the right hand side of your clock radio is provided for connecting the audio signal to an external amplifier. Inserting a plug into the line output socket will not mute the internal loudspeaker.

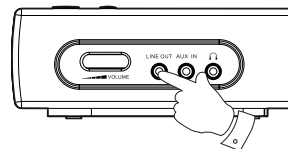

## System reset

If your radio fails to operate correctly, or some digits on the display are missing or incomplete carry out the following procedure.

1. Switch on your radio.
2. Press and hold in the Info button to enter the setting menu when the radio is in the DAB or FM mode. Press the Tuning up or down until 'System Setting' shown on the display. Press the Select button to enter the menu.
3. Press the Tuning Up or Down button until "Factory Reset" appears on the display, press the Select button the display shows "Factory Reset". Press the Tuning up or down button to highlight 'Yes' and press the Select button to perform factory reset. If you do not wish to carry out a system reset, highlight 'NO' and then press the Select button. The display will revert to the previous menu.
4. If a factory reset is performed, the station list and presets will be erased. Display will show "Restaring" and "0:00", also back to standby mode. You need to start over the settings again as the time you used the clock radio for the first time. In case of malfunction due to electrostatic discharge, reset the product (reconnection of power source may be required) to resume normal operation.

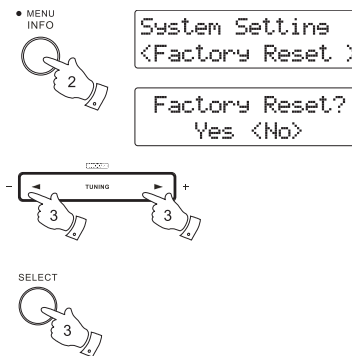

## Software upgrade

From time to time, new software features for your radio may be developed. Your radio has therefore been designed to allow its internal software to be updated using your USB upgrade port. You should not attempt to update your radio unless it is recommended to you by Sangean Customer Services. Updating the software may remove all radio station presets and settings from your radio.

Software updates for your radio may be available in the future.

As software updates become available software and information on how to update your radio can be found at <http://www.sangean.com>

For more information, please contact our Head Office by sending an email to [contact@sangean.com](mailto:contact@sangean.com)

1. Plug the USB into the USB socket in the rear of the unit and your PC USB port.
2. Press and hold the Menu/Info button to enter the setting menu when the radio is in the DAB or FM mode. Press the Tuning up or down until 'System Setting' shown on the display and press the Select button to enter the setting.
3. Press the Tuning up/down button until 'Software Upgrade' appeared on the display. Press the Select button to enter the setting.
4. Go to the website above to download the latest software. Follow the on-screen instructions provided with the upgrade software to complete the software upgrade.

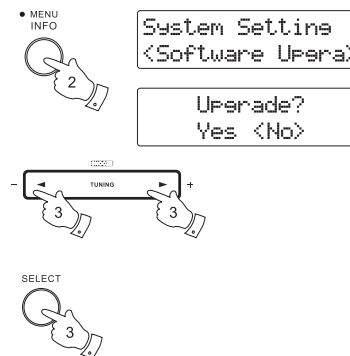
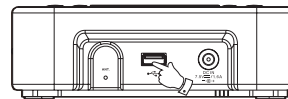



## USB socket for iPhone/Smartphone charging

Your radio has a USB socket which is intended only for charging an iPhone, smart phone or similar devices. Charge time may vary and in some cases may take longer to charge than when using the manufacturers charging unit supplied with the smart phone.

1. The radio can charge the iPhone, smart phone or similar devices when the radio is in power on or standby mode and in DAB/FM/AUX mode.
2. Connect your smart phone to the USB charging socket on the rear of your radio.
3. Your iPhone or smart phone will begin to charge.
4. Once your iPhone or smart phone has fully charged remove the USB cable.

### **Important:**

- The charger may not supply power to some USB devices.
- When not using or after charging, remove the USB cable.
- Do not connect power source to USB port. Otherwise there is a risk of fire. The USB port is only intended for charging lower voltage device.
- Do not insert a nail, wire, etc. into the USB power supply port. Otherwise a circuit short may cause smoke and fire.
- Do not connect this USB socket with your PC USB port, as it is highly possible that it may cause breakdown of the units.
- Never use the USB socket in rainy or moist conditions to prevent moisture from entering the radio.

## Cautions

Do not allow this clock radio to be exposed to water, steam or sand. Do not leave your clock radio where excessive heat could cause damage such as in a parked car where the heat from the sun can build up even though the outside temperature may not seem too high.

- The name plate is located on the underside of the unit.
- Your clock radio should not be exposed to dripping or splashing and that no objects filled with liquids, such as vases, shall be placed on the clock radio.
- It is recommended to operate the product such that there is a minimum distance (10cm recommended) to adjacent objects in order to ensure good ventilation.
- The ventilation of the product should not be restricted by covering it or its ventilation openings with items such as newspapers, tablecloths, curtains etc.
- No naked flame sources such as lighted candles should be placed on the product.
- It is recommended to avoid using or storing the product at extremes of temperature. Avoid leaving the unit in cars, on window sills, in direct sunlight etc.

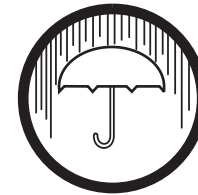
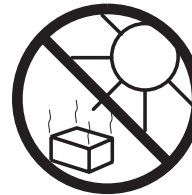

## Specifications

Power Requirements	
Mains	AC 100~240 V 50/60 Hz, DC 7.5V / 1.6A (AC / DC switching adaptor)
Frequency Coverage	
FM	87.5-108 MHz
DAB	174.928-239.200 MHz
Circuit Feature	
Loudspeaker	1x75 mm
Output Power	0.6Watt
Headphone socket	3.5mm dia
Auxiliary Input socket	3.5mm dia
Line out socket	3.5mm dia
Aerial System	FM Wire aerial
	DAB Wire aerial
USB socket	5V / 1A Max.
Operating temperature range	0°C to +35°C
Information on Power Consumption	
Power standby	The device has a standby mode with a power consumption of less than 0.8W.
AUX mode	In AUX mode, when there is no signal output, the idle power consumption is 0.8W after 15 minutes.

※ The barcode label on the product is defined as below:

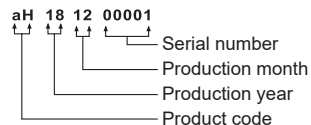

*Sangean reserves the right to amend the specifications without notice.*



**RECYCLING** This product bears the selective sorting symbol for Waste electrical and electronic equipment (WEEE). This means that this product must be handled pursuant to European directive 2012/19/EU in order to be recycled or dismantled to minimize its impact on the environment.